

Product Parts Breakdown

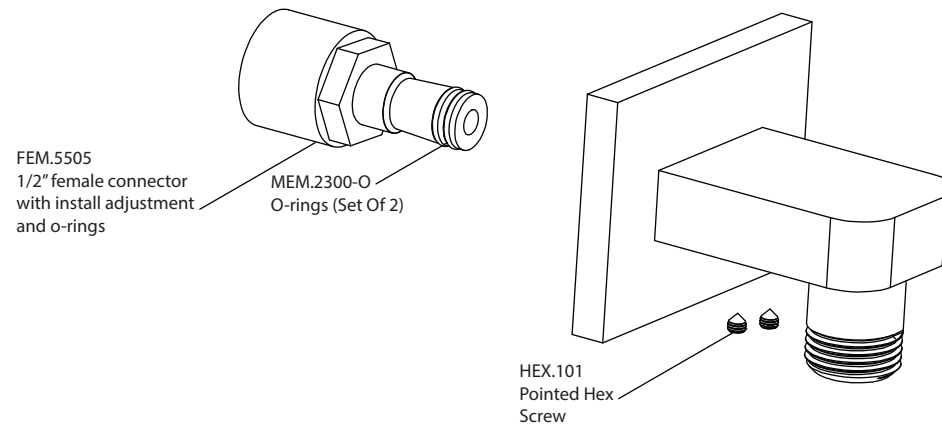

isenberg
innovation+design

196.5505

Ver 2.53